

CHARACTERISTICS

	STANDARD	AVAILABLE OPTIONS
Technology	Eccentric Disc Mouvex®	
Maximum Flow rate at 1 cSt L/h (GPM)	12000 (52.8)	
Cubic capacity L (cu.in)	0.37 (22.5)	
Ports	SMS 1145	DIN 11851 Ringed end fitted (for hose)
Pump heating	None	
Dimensions mm (in.) (With SMS connections)	A	427.5 (16.8)
	B	361 (14.2)
	C	165 (6.5)
	D	329 (13)
Weight kg (lbs)	62 (137)	

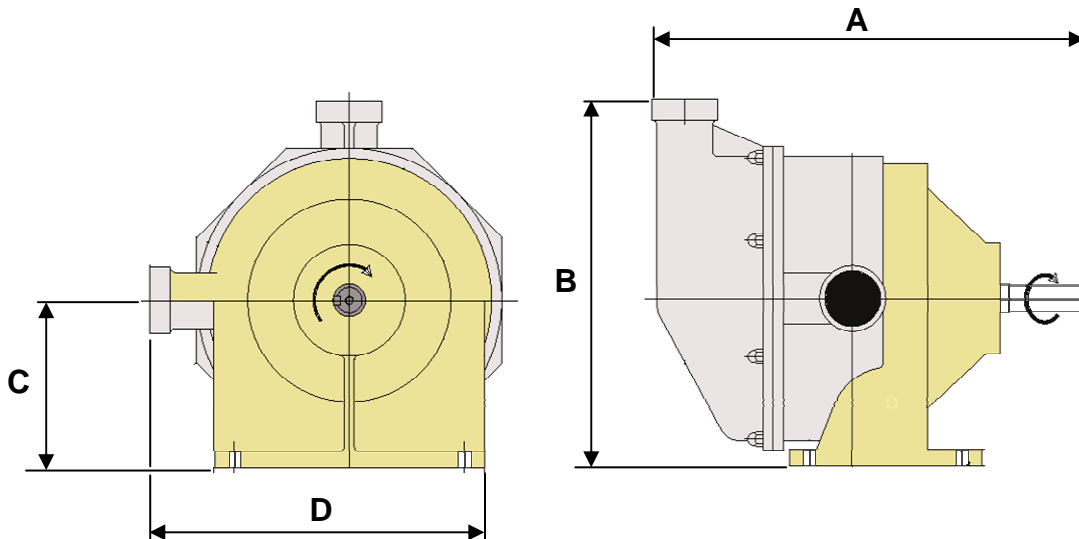

OPERATING LIMITS

	STANDARD MATERIALS
Minimum temperature °C (°F)	0 (32)
Maximum temperature °C (°F)	80 (176)
Maximum viscosity cSt (SSU)	15000 (69000)
Maximum differential pressure bar (psi)	6 (87)
Maximum inlet pressure barg (psig)	3 (44)
Maximum speed rpm	500
Maximum solid particle size mm (in)	2 (0.08)
Maximum soft particle size mm (in)	10 (0.39)

MATERIALS OF CONSTRUCTION

Part No	PART NAME	STANDARD MATERIALS	AVAILABLE OPTIONS
100	Inlet tube	316L Stainless Steel	Polished external surfaces
201	Cylinder	316L Stainless Steel	
301	Piston	CY5SnBiM (anti galling alloy)	
401	Front cover	316L Stainless Steel	Polished external surfaces
	Seal rings	FKM	EPDM
	Screws, nuts, washers	316L Stainless Steel	
	Transmission Assembly		
596	Bearings	Ball / Roller	
	Sleeve Assembly	FKM	EPDM
	Housing	Cast iron	
	Screws	Steel	
	Transmission Lubricant	Castor oil	

