

CHARACTERISTICS

	STANDARD	AVAILABLE OPTIONS
Technology	Eccentric Disc Mouvex®	
Maximum Flow rate at 1 cSt L/h (GPM)	800 (3.52)	
Cubic capacity L (cu.in)	0,0133 (0,8202)	
Inlet chamber volume L (cu.in)	0,15 (9,15)	
Outlet chamber volume L (cu.in)	0,08 (4,89)	
Ports	DIN20 (DIN 11851)	CLAMP DN20 (DIN 32876) 1/2" BSP 1/2" NPT SMS25 (SMS 1145) CLAMP ISO25 (ISO 2852) CSF DN20 (Connect S) BS4825-5 DN20 (RJT)
Motor Flange	IEC FT100-B34	NEMA143, Foot bracket
Dimensions mm (in.) (1)	A	242.5 (9.55)
	B	138 (5.43)
	C	116 (4.57)
	D	61 (2.39)
	E	96 (3.78)
	F	30.5 (1.20)
	G	80 (3.15)
Weight kg (lbs)	8 (17.7)	

(1) Valid with NPT, BSP or DIN connections. For other connections types, consult us.

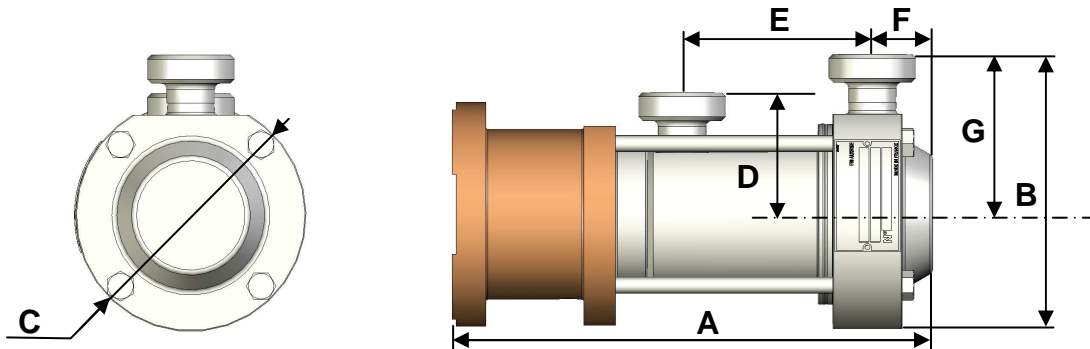

OPERATING LIMITS

	STANDARD MATERIALS
Minimum temperature °C (°F)	-15 (5)
Maximum temperature °C (°F)	Process: 110 (230) Washing / Rinsing / Sterilization : 121 (250)
Maximum viscosity cSt (SSU)	2000 (9270)
Maximum differential pressure bar (psi)	3 (55)
Maximum inlet pressure barg (psig)	Process 1 (14.5) Cleaning 2 (29)
Maximum speed rpm	1000
Maximum solid particle size mm (in)	0.4 (0.015)
Maximum soft particle size mm (in)	0.8 (0.030)

MATERIALS OF CONSTRUCTION

Part No	PART NAME	STANDARD MATERIALS	AVAILABLE OPTIONS
100	Inlet Tube	316L Stainless Steel (low carbon)	
201	Cylinder	316L Stainless Steel (low carbon)	
301	Disc	CY5SnBiM (anti galling alloy)	
309	Disc Nut	316Ti Stainless Steel (Titanium Alloy)	
400	Outlet Cover	316L Stainless Steel (low carbon)	
415	Bolts	316L Stainless Steel (low carbon)	
781	Adaptor Flange	Cast iron	
782	Screws	Steel	
596	Transmission Assembly		
	Bearings	Ball / Roller / Needle	
	Bellows Assembly	316Ti & 316 L Stainless Fabrication	
	Housing	Stainless steel	
	Screws	Steel	
	Transmission Lubricant	Greased for life bearings	
	Seal Rings	Fluorocarbon (FKM) O-Rings	PTFE Encapsulated O-rings

